

SPEC SHEET

MOONSHADE

Acoustic Lighting



Features

- Highly effective noise absorption
- 3 sizes and a wide range of colors
- High performance direct distribution
- UGR<19
- Height adjustable 3m suspensions and clear teflon cable
- Can be mounted flush to ceiling



RoHS

www.54lighting.co.uk

54 lighting

DIMENSIONS

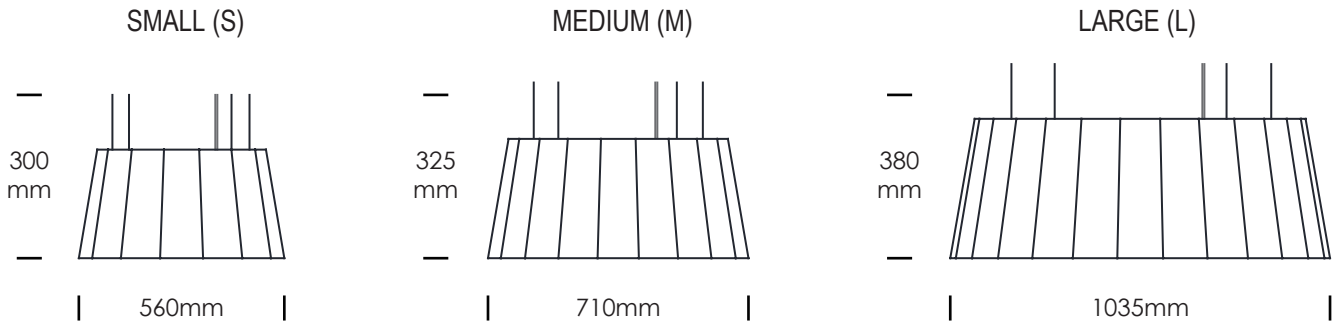

DISTRIBUTIONS

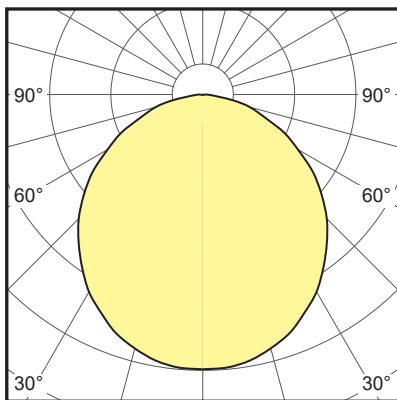

MATERIAL SPECIFICATIONS

MATERIAL	100% Recyclable PET fiber
DENSITY	1900g/m ²
FIRE TEST	GB8624 B1
SOUND ABSORPTION	Noise reduction coefficient (NRC) >0.8
TESTING PROCEDURE	AS ISO 354 - 2006 / AS ISO 11654 - 1997

MOONSHADE

Acoustic Lighting

ORDERING INFO

MOONSHADE - SMALL MODEL: MS-S



LIGHT DISTRIBUTION	Direct
DELIVERED LUMENS	2414lm@3000K / 2557lm@4000K
EFFICACY	Up to 91lm/W
CCT	3000K / 3500K / 4000K / RGBW
CRI	> 90
POWER	28W
DIMMING	Non-dim / 0/1-10V / DALI
INPUT	220-240V AC
CABLE	Length 3 m, clear teflon cable
SIZE	φ560x300mm
FINISH	See color codes as shown
WEIGHT(NET)	6.5KG

MOONSHADE - MEDIUM MODEL: MS-M

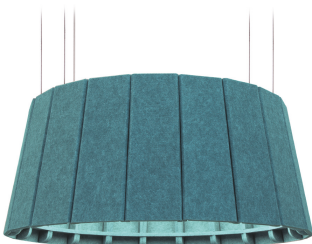

LIGHT DISTRIBUTION	Direct
DELIVERED LUMENS	4022lm@3000K / 4261lm@4000K
EFFICACY	Up to 90lm/W
CCT	3000K / 3500K / 4000K / RGBW
CRI	> 90
POWER	47W
DIMMING	Non-dim / 0/1-10V / DALI
INPUT	220-240V AC
CABLE	Length 3 m, clear teflon cable
SIZE	φ710x325mm
FINISH	See color codes as shown
WEIGHT(NET)	10KG

MOONSHADE

Acoustic Lighting

MOONSHADE - LARGE MODEL: MS-L

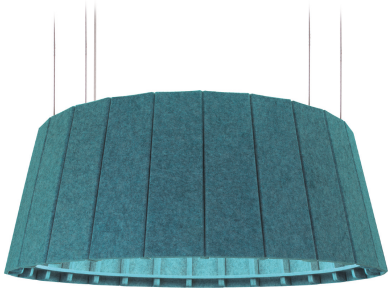

LIGHT DISTRIBUTION	Direct
DELIVERED LUMENS	8787lm@3000K / 9307lm@4000K
EFFICACY	Up to 92lm/W
CCT	3000K / 3500K / 4000K / RGBW
CRI	> 90
POWER	100W
DIMMING	Non-dim / 0/1-10V / DALI
INPUT	220-240V AC
CABLE	Length 3 m, clear teflon cable
SIZE	φ1035x380mm
FINISH	See color codes as shown
WEIGHT(NET)	18.5KG

COLOR CODE



Off White (OW)



Brown (BR)



Yellow (Y)



Orange (O)



Red (R)



Dirty Pink (DP)



Light Grey (LG)



Dark Grey (DG)

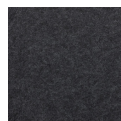

Black (BK)

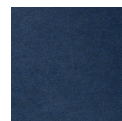

Dark Blue (DB)

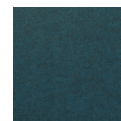

Forest Green (FG)



Cyan (C)